

KREA

COLORI
E MATERIA



GIGACER[®]

La materia prende forma nel colore, esaltandosi con effetti di ispirazione naturale come le sfumature dei toni e i colori vivaci delle terre e delle rocce. Krea è tutto questo, respira di aria nuova, aprendo uno spazio in più alla creatività con l'uso del colore. Ambienti che si arricchiscono di una vibrazione monocroma variegata, che gioca con la materia della superficie interpretando il cemento o la resina in modo nuovo e sorprendente pur conservando tutta la funzionalità e i benefici di un grès porcellanato non smaltato.

KREA È UNA DIMENSIONE DI ARMONIA TRA ELEGANTE MINIMALISMO E LIBERTÀ CROMATICA.

The material takes its form in the colour, exalting itself with natural-inspired effects such as nuances of tones and vivid colours of the earth and the rocks. This is KREA, it breathes new air, opening an extra space to the creativity with the use of the colour. Environments that are enriched with a variegated and monochromatic vibration, which plays with the material of the surface, interpreting the cement and resin effect in a new and more surprising way, while retaining all the functionality and benefits of an unglazed porcelain slab.

KREA IS A DIMENSION OF HARMONY BETWEEN AN ELEGANT MINIMALISM AND A CHROMATIC FREEDOM.

KREA

COLORI
E MATERIA



INDICE INDEX

INTRO	2
COLORI / COLOURS	6
FORMATI E SPESSORI / SIZES AND THICKNESSES	8
COLLEZIONE / COLLECTION	10
BLUE	12
ORANGE	18
GREEN	24
RED	30
SNOW	36
SILVER	42
NUT	48
GROUND	54
AVANTIME CHROMATIC VISION SYSTEM	60
GUIDA PRODOTTO / PRODUCT GUIDE	72

COLORI
COLOURS

01

BLUE

02

ORANGE

05

SNOW

06

SILVER

03

GREEN

04

RED

07

NUT

08

GROUND

FORMATI E SPESSORI

SIZES AND THICKNESSES

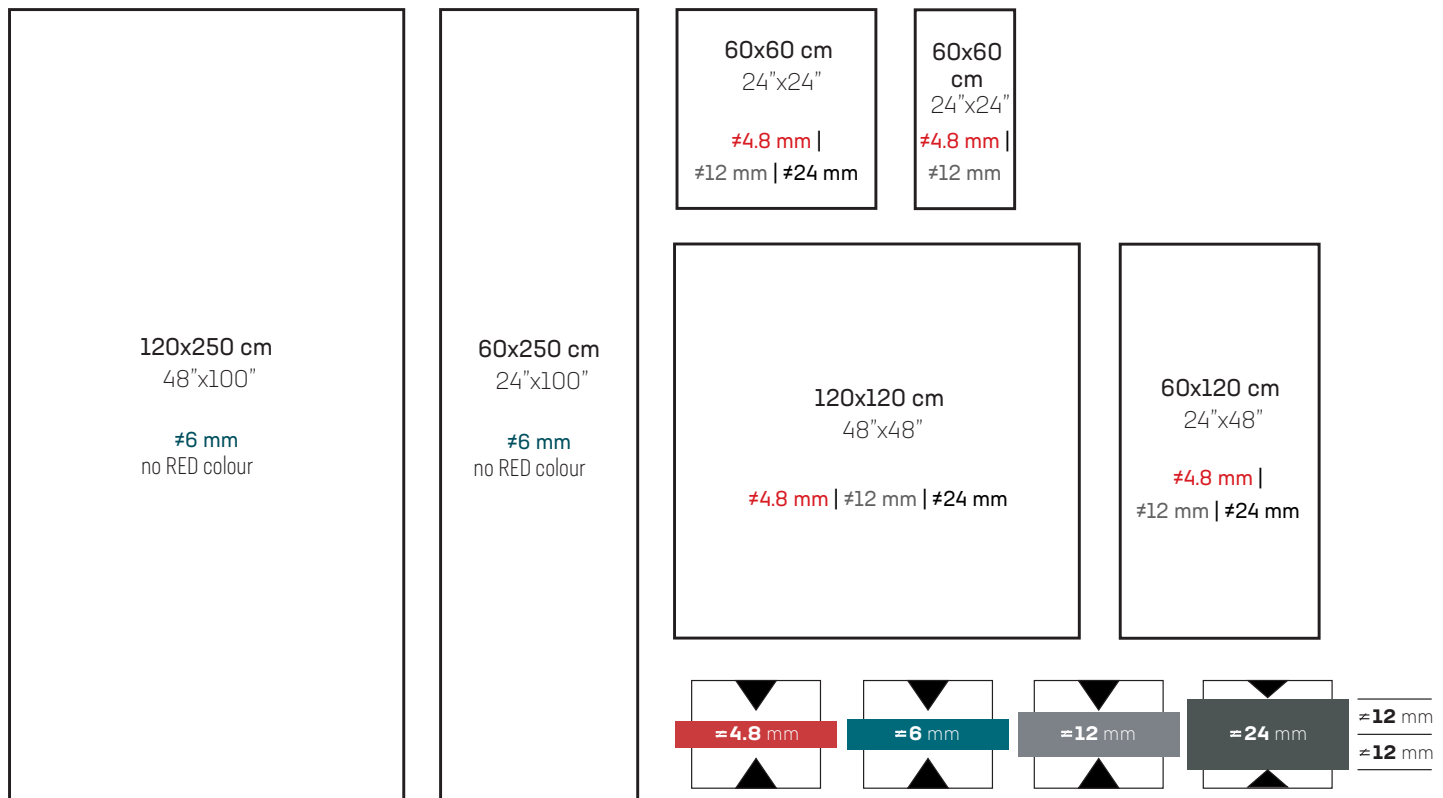

PLAYONE

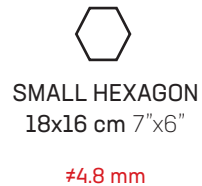

8
COLORI
COLORS

17
FORMATI
SIZES

5
MOSAICI
MOSAICS

4
SPESSORI
THICKNESSES





KR
COLLEZ

Otto colori che interpretano la materia dei cementi e delle resine colorate in chiave moderna. La serie Krea consente di utilizzare colori vivaci e sfumature decise, oltre che nel residenziale, anche nei progetti pubblici, grazie alle elevate caratteristiche tecniche fornite dal gres porcellanato non smaltato. I colori, infatti, sono ottenuti esclusivamente tramite la pressatura in un unico corpo di polveri e materie prime, che resistono all'alto traffico e al calpestio prolungato. La struttura superficiale, nello spessore 4,8 mm, 6 mm e 12 mm, è la stessa della serie Concrete. E' quindi possibile combinare le due serie, entrambe rettificate e monocalibro, in tutti i formati disponibili.

Eight colours that interpret cements and coloured resins in a modern way. Krea range allows you to use bright colors and bold shades both in residential and in public projects, thanks to the high technical characteristics provided by the unglazed porcelain stoneware. All colours, in fact, are obtained only by pressing powders and raw materials in a single body, allowing the product to withstand the high traffic in public places. The surface structure, in 4.8 mm, 6 mm and in 12 mm thickness is the same as in Concrete range. It is therefore possible to combine the two ranges, both rectified in the same calibre, in all available formats.



01

KREA
BLUE

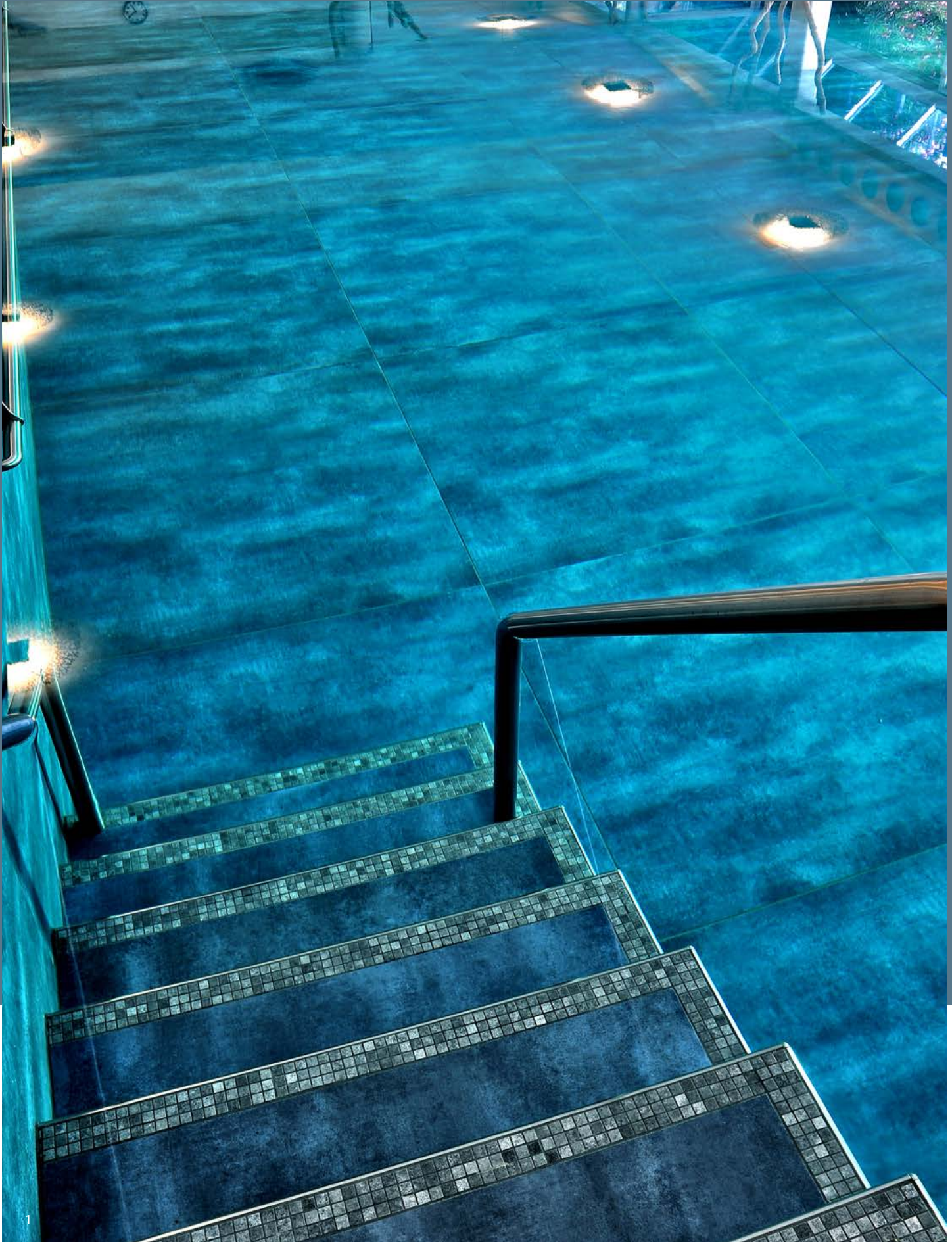



1.

PAVIMENTO | FLOOR

Krea Blue 120x120 48"x48" / #12 mm

SCALE | STEPS

Krea Blue #4.8 mm Gigacer Service / Krea Snow Mosaic 1.5x1.5 30x30 12"x12" / #4.8 mm

2.

PARETE | WALL

Krea Blue 120x120 48"x48" / #4.8 mm

PAVIMENTO | FLOOR

Krea Blue Mosaic 1.5x1.5 30x30 12"x12" / #4.8 mm



3



3.

PARETE | WALL

Krea Blue, Krea Snow Brick Bar 7,5x60 3"x24" / #12 mm

4.

PAVIMENTO | FLOOR

Krea Snow 120x120 48"x48" / #12 mm

PARETE | WALL

Krea Blue 120x120 48"x48" / #4.8 mm



02

KREA
ORANGE



1



1.
PAVIMENTO | FLOOR
Krea Ground 120x120 48"x48" / #12 mm
PARETE | WALL
Krea Ground, Krea Orange Large Hexagon
36x31 14"x12" / #4.8 mm

2.
PAVIMENTO | FLOOR
Krea Ground 120x120 48"x48" / #4.8 mm
Krea Orange Mosaic 1.5x1.5 30x30 12"x12" / #4.8 mm
PARETE | WALL
Krea Ground, Krea Orange Large Hexagon
36x31 14"x12" / #4.8 mm
Krea Orange Mosaic 1.5x1.5 30x30 12"x12" / #4.8 mm
Krea Orange 120x250 48"x100" / #6 mm





3.

PAVIMENTO | FLOOR

Krea Orange 120x120 48"x48" / #12 mm

PARETE | WALL

Krea Orange, Krea Silver 20x120 8"x48" / #4,8 mm Gigacer Service

Krea Green, Krea Red, Krea Blue 15x120 6"x48" / #4,8 mm

4.

LAVABO "DOUBLE" | WASHBASIN "DOUBLE"

Krea Orange 180x50 71"x19 1/2" / #6 mm

The background is an abstract composition of flowing, organic shapes in various shades of green, from light lime to dark forest green. The shapes appear to be layered and curved, creating a sense of movement and depth. The lighting is soft, highlighting the curves and creating subtle gradients.

03

KREA
GREEN





1. / 2.

PAVIMENTO | FLOOR

Krea Snow 120x120 48"x48" / #12 mm

Krea Green Mosaic 1.5x1.5 / 30x30 12"x12" / #4,8 mm

PARETE | WALL

Krea Green 30x120 12"x48" / #4,8 Gigacer Service

Krea Green Mosaic Stripes 15x120 6"x48" / #4,8 mm

Krea Green, Krea Snow 15x15 6"x6" / #4,8 mm Gigacer Service



3



3.

PAVIMENTO | FLOOR

Krea Snow, Krea Green 30x30 12"x12" / #4.8 mm
 Krea Red Diamond 18x31 7"x12" / #4.8 mm
 Krea Silver Plate 9x30 3 1/2"x12"
 Krea Silver Brick 9x18 3 1/2"x7"

4.

PARETE | WALL

Krea Green, Krea Snow Brick Bar 7,5x60 3"x24" / #12 mm
 Krea Green 120x120 48"x48" / #4.8 mm
 Krea Green, Krea Red, Krea Snow Small Hexagon
 18x16 7"x6" / #4.8 mm



04

KREA
RED





1./2.

PAVIMENTO | FLOOR

Krea Red 60x60 24"x24" / #4.8 mm

Krea Silver 10x60 4"x24" / #4.8 mm Gigacer Service

Concrete Ice 10x10 4"x4" / #4.8 mm Gigacer Service



3



3.

PAVIMENTO | FLOOR

Krea Red 60x60 24"x24" / #12 mm

Krea Blue 30x60 12"x24" / #12 mm

4.

PARETE | WALL

Krea Red 120x120 48"x48" / #4.8 mm

A large, textured ice wall, possibly a glacier or ice shelf, dominates the background. The ice is white and blue, with visible cracks and crevasses. In the foreground, there is a body of water with small ice floes. A large, white, stylized number '05' is overlaid in the center of the image.

05

KREA
SNOW



1



1./2.
PAVIMENTO | FLOOR
Krea Snow 120x120 48"x48" / #12 mm



3



3./4.
PAVIMENTO | FLOOR
Krea Snow 60x120 24"x48" / #12 mm

The image features a dark, monochromatic background with a complex, layered texture. The texture consists of numerous thin, overlapping layers that create a sense of depth and movement, similar to the appearance of aged paper or sedimentary rock. The layers are oriented in various directions, some running vertically and others diagonally. The lighting is subtle, highlighting the edges and creases of the layers, which adds to the tactile quality of the image. In the center of the image, the number '06' is displayed in a large, clean, white sans-serif font. The '0' is a simple oval shape, and the '6' has a classic, slightly rounded top and a distinct bottom loop. The white color of the number provides a sharp contrast against the dark, textured background, making it the central focus of the composition.

06

KREA
SILVER



1



1./2.

PAVIMENTO | FLOOR

Krea Silver 120x120 48"x48" / #12 mm





3.
PAVIMENTO | FLOOR
Krea Silver 120x120 48"x48" / #12 mm

3



07

KREA
NUT





1.
PAVIMENTO | FLOOR
Krea Nut 120x250 48"x100" / #6 mm

1





2.

PAVIMENTO | FLOOR

Krea Nut 120x120 48"x48" / #12 mm

PARETE | WALL

Krea Mix Stripes Mosaic 15x120 6"x48" / #4.8 mm

Krea Nut, Krea Silver, Krea Snow 20x120 8"x48" / #4.8 mm Gigacer Service

3.

PAVIMENTO | FLOOR

Krea Nut 60x60 24"x24" / #12 mm

KREA
COLORI E MATERIA

08

KREA
GROUND





1./2.
PAVIMENTO | FLOOR
Krea Ground 120x120 48"x48" / #12 mm





3.
PAVIMENTO | FLOOR
Krea Ground 120x250 48"x100" / #6 mm

PARETE | WALL
Krea Ground, Krea Orange Large Hexagon
36x31 14"x12" / #4.8 mm
Krea Green, Krea Snow Brick Bar 7,5x60 3"x24" / #12 mm
Krea Green 120x120 48"x48" / #4.8 mm
Krea Green, Krea Red, Krea Snow Small Hexagon
18x16 7"x6" / #4.8 mm

LAVABO "DOUBLE" | WASHBASIN "DOUBLE"
Krea Orange 180x50 71"x19 1/2" / #6 mm Gigacer Service



KR
AVAN
CRHO

GIGACER offre un'inedita gamma di formati, spessori e colori naturali per progettare ogni tipo di superficie: pavimenti e rivestimenti, spazi residenziali e commerciali, indoor e outdoor, mobili, facciate ventilate e piscine. Uno strumento duttile e ricco di soluzioni per il progetto architettonico.

GIGACER ha ideato Avantime 'a new vision for architecture': un nuovo modo di vedere e interpretare un brand ceramico. Avantime è un innovativo sistema di lastre ceramiche incentrato su colori, formati, mosaici e decori. Avantime unisce in modo trasversale tutte le collezioni GIGACER regalando effetti e abbinamenti unici e originali, grazie alla filosofia di prodotto mantenuta costante e univoca nel tempo.

Nel progetto architettonico il colore è determinante per la scelta dei materiali per pavimentazioni e rivestimenti, nasce così Chromatic Vision, un'inedita gamma cromatica comprensiva di tutte le collezioni GIGACER che le ripropone secondo una logica ispirata a varie scale cromatiche e tonali.

GIGACER offers an outstanding range of formats, thicknesses and natural colours in order to design any type of surface: floors and walls, residential and commercial spaces, indoor and outdoor, furniture, ventilated facades and swimming pools. A ductile tool full of solutions for the architectural project.

Avantime is an innovative ceramic slabs' system focused on colours, formats, mosaics and decors. Avantime joins in a transversal way all the GIGACER collections, offering effects and unique and original matching thanks to the product philosophy kept constant and univocal over time.

In the architectural project, the colour is important for the choice of the materials for surface and covering; for this reason the Chromatic Vision born, an outstanding chromatic range including all the GIGACER collection, which proposes them following a logic inspired by various chromatic and tonal scales.



1



2

1.

PARETE | WALL

Krea Blue 60x120 24"x48" / #4.8 mm / Déco Artic 120x250 48"x100" / #6 mm

PAVIMENTO | FLOOR

Krea Silver 120x120 48"x48" / #12 mm

LAVABO LEFT | LEFT WASHBASIN

Krea Blue 119x50 48"x19 1/2" / #4.8 mm

2.

PAVIMENTO | FLOOR

Krea Silver, Concrete Graphite, Concrete Ice Diamond
18x31 7"x12" / Krea Silver, Concrete Ice Plate 9x30 3 1/2"x12"
Concrete Graphite 30x60 12"x24"

KREA
COLORI E MATERIA



3



3.

PAVIMENTO | FLOOR

Krea Green, Concrete Ice 30x30 12"x12" / #4.8 mm Gigacer Service
 Krea Snow, Concrete Ice 30x60 12"x24" / #4.8 mm

4.

PAVIMENTO | FLOOR

Krea Blue, Krea Silver 30x30 12"x12" / #4.8 mm / Gigacer Service
 Concrete Ice Plate 9x30 3 1/2"x12" / #4.8 mm
 Concrete Ice Small 9x9 3 1/2"x 3 1/2" / #4.8 mm



5



5.
PAVIMENTO | FLOOR
 Krea Orange, Concrete White, Concrete Dust Diamond 18x31 7"x12" / #4.8 mm
PARETE | WALL
 Krea Orange 120x120 48"x48" / #4.8 mm
 Krea Orange Stripes Mosaic 15x120 6"x48" / #4.8 mm



6.
PAVIMENTO | FLOOR
 Krea Orange 120x120 48"x48" / #12 mm
 Concrete Brown 60x120 24"x48" / #12 mm
PARETE | WALL
 Déco Tropic 120x250 48"x100" / #6 mm
 Concrete Brown 60x250 24"x100" / #6 mm



7



7.
PAVIMENTO | FLOOR
Krea Red 10x60 4"x24" / #4.8 mm Gigacer Service
Krea Snow 10x10 4"x4" / #4.8 mm Gigacer Service
Concrete Ice 60x60 24"x24" / #4.8 mm

8.
PAVIMENTO | FLOOR
Krea Snow 60x60 24"x24" / #4.8 mm
Krea Red 10x10 4"x4" / #4.8 mm / Gigacer Service
Concrete Ice 10x60 4"x24" / #4.8 mm / Gigacer Service





9. / 10.

PAVIMENTO | FLOOR

Krea Orange, Concrete White, Concrete Dust Diamond 18x31 7"x12" / #4.8 mm

Krea Orange 20x60 8"x24" / #4.8 mm / Gigacer Service



GUIDA PRODOTTO PRODUCT GUIDE

SOSTENIBILITÀ / SUSTAINABLE THINKING	74
LAVORAZIONI BORDI E TOP / WORKTOP AND EDGE MACHINING	76
LAVABI E PIATTI DOCCIA / WASHBASINS AND SHOWER TRAYS	78
24 MM PAVIMENTI SOPRAELEVATI / 24 MM RAISED FLOORS	80
PLAYONE	82
PEZZI SPECIALI / SPECIAL TRIMS	84
GIGACER SERVICE	85
DESTINAZIONI D'USO / INTENDED USE CLASSIFICATION	86
SUGGERIMENTI PER LA POSA / INSTALLATION SUGGESTION	86
INDICE DI STONALIZZAZIONE / SHADE VARIATION INDEX	87
CALIBRI / CALIBERS	87
CARATTERISTICHE TECNICHE / TECHNICAL SPECIFICATION	88
NOTE TECNICHE / TECHNICAL NOTES	89
IMBALLI / PACKAGING	90
CERTIFICAZIONI / CERTIFICATIONS	91

SOSTENIBILITÀ

SUSTAINABLE THINKING

Curiamo con particolare attenzione:

- la sicurezza ed il comfort del personale addetto alla produzione;
- il rispetto dell'ambiente in cui sorge lo stabilimento;
- la sicurezza del personale sul cantiere, garantita da imballaggi studiati per facilitare la movimentazione e completamente riciclabili.

Produciamo grandi lastre ceramiche grazie all'applicazione di tecnologie all'avanguardia, nel rispetto (spesso anche in senso molto migliorativo) delle vigenti normative europee sull'ambiente. Per questo i macchinari si trovano in ambienti insonorizzati, l'illuminazione della linea produttiva è a basso regime, esiste un monitoraggio ambientale in tempo reale, il sistema di imballaggio - sidepack - prevede, prima della pressatura, l'utilizzo di quantità di cartone minime e comunque i materiali dell'imballo sono completamente riciclabili e privi di colle.

La nuova lastra sottile 4.8 è di fatto il nuovo orizzonte del risparmio energetico in ceramica: offre la possibilità di produrre gres porcellanato di altissima qualità con notevole risparmio di energia sia durante il processo di cottura sia durante il trasporto.

INNOVAZIONE TECNOLOGICA

Un processo produttivo intelligente.

Il processo produttivo di GIGACER prevede la preparazione preliminare di due formati principali, grandi lastre in gres porcellanato 120x250 e 120x120 cm, multistrato o tutta massa, che possono essere successivamente tagliate e modificate a freddo in molteplici altri formati e superfici mantenendo la massima garanzia di requisiti tecnici qualitativi ed estetici.

Questa serie di lastre caratterizzate da superiori prerogative tecniche ed estetiche viene prodotta in gres porcellanato a tutta massa multistrato con una tecnologia assolutamente innovativa. L'impianto è stato progettato appositamente per produrre grandi formati e utilizza la tecnologia definita "CONTINUA" che prevede prima della pressatura, una fase di precompattazione della lastra multistrato a tutta massa che permette di ottenere speciali effetti decorativi senza ricorrere all'uso di smalti, ma solo con la distribuzione di impasti porcellanati colorati di qualità. Gli spessori delle lastre prodotte sono di 12 mm, 6 mm e 4.8 mm.

We pay close attention to:

- the safety and comfort of our production staff;
- the respect for the environment in and around the factory;
- the safety of tile layers in the building site, which is guaranteed by the specially designed packaging that makes movement easier and that is completely recyclable.

We manufacture large porcelain slabs thanks to the application of advanced technologies, in accordance with the current European environmental standards (and often with even better results). For this reason the engines are installed in soundproof areas, the lighting around the production area is low emission, there is an environmental monitoring in real time, the complete packaging (sidepack) uses minimum quantities of cardboard and, however, the material used for packaging is completely recyclable and glueless.

The new 4.8 thin slab is in fact the most advanced system concerning energy saving: it gives us the possibility of manufacturing high quality porcelain stoneware tiles with a remarkable energy saving, both for firing and carriage.

TECHNOLOGICAL INNOVATION

An intelligent production process.

GIGACER production process starts from large porcelain slabs, size 120x250 e 120x120 cm, homogeneous multilayer. The slabs can then be cut in many other submultiples and worked again to get different finishes, preserving their top quality and aesthetic features.

These homogeneous multilayer porcelain slabs show superior technical and aesthetical characteristics thanks to a highly innovative technology. The equipment has been realized on purpose to manufacture large sizes and uses an innovative technology called "CONTINUA". This technology foresees a pre-compacting phase before pressing, that allows to achieve special decorative effects without using glazes, but only distributing the porcelain mixed powders on the body. The thickness of the manufactured slabs are 12 mm, 6 mm and 4.8 mm.

G
I
G
A
C
E
R



LAVORAZIONI BORDI

EDGE AND WORKTOP MACHINING



LAVORAZIONI BORDI

EDGE MACHINING



A **Costa a profilo inclinato**
Reverse angled ridge 45°



C **Costa a toro**
Full rounded ridge



E **Veletta a vista**
L-shaped squared ridge



B **Costa pari a tondino**
Rounded straight ridge



D **Costa pari lati a vista**
Double straight squared ridge



F **Taglio grezzo**
Raw edge



LAVORAZIONI TOP

WORKTOP MACHINING

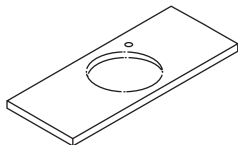

Foro grezzo circolare o sagomato
Raw circular or shaped hole

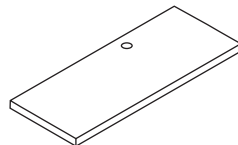

Foro per miscelatore
Mixer hole

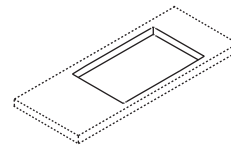

Foro grezzo rettangolare
Raw rectangular hole

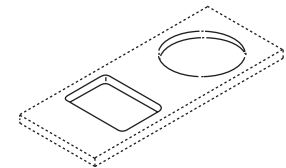

Foro satinato
Satin hole

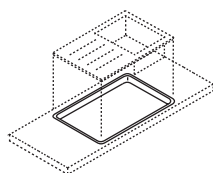

Foro filo top
Top-aligned hole

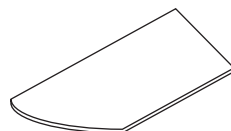

Terminale raggionato
Radiused final

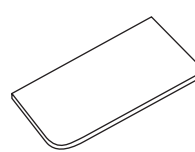

Angolo raggionato
Radiused corner

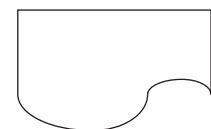

Sagomatura grezza
Shaping raw



LAVABI E PIATTI DOCCIA WASHBASINS AND SHOWER TRAYS



LAVABI WASHBASINS

MIDDLE

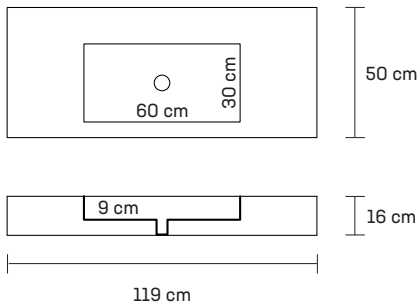

RIGHT

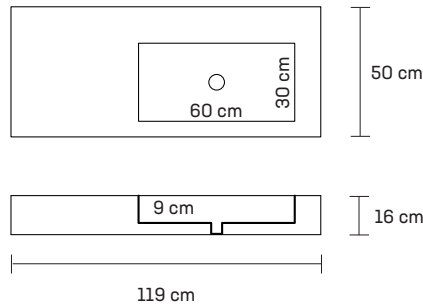

LEFT

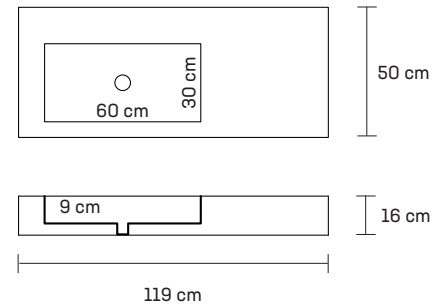

DOUBLE

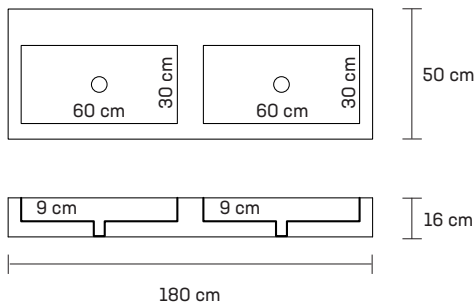

COLORE COLOUR	MODELLO MODEL	FORMATO CM SIZE
Tutti i colori Krea / All Krea colors	MIDDLE	119x50 48"x19 1/2" #4.8mm
Tutti i colori Krea / All Krea colors	LEFT OR RIGHT	119x50 48"x19 1/2" #4.8mm
Tutti i colori Krea / All Krea colors (no Red)	DOUBLE	180x50 71"x19 1/2" #6mm

PIATTI DOCCIA
SHOWER TRAYS

MODELLO A

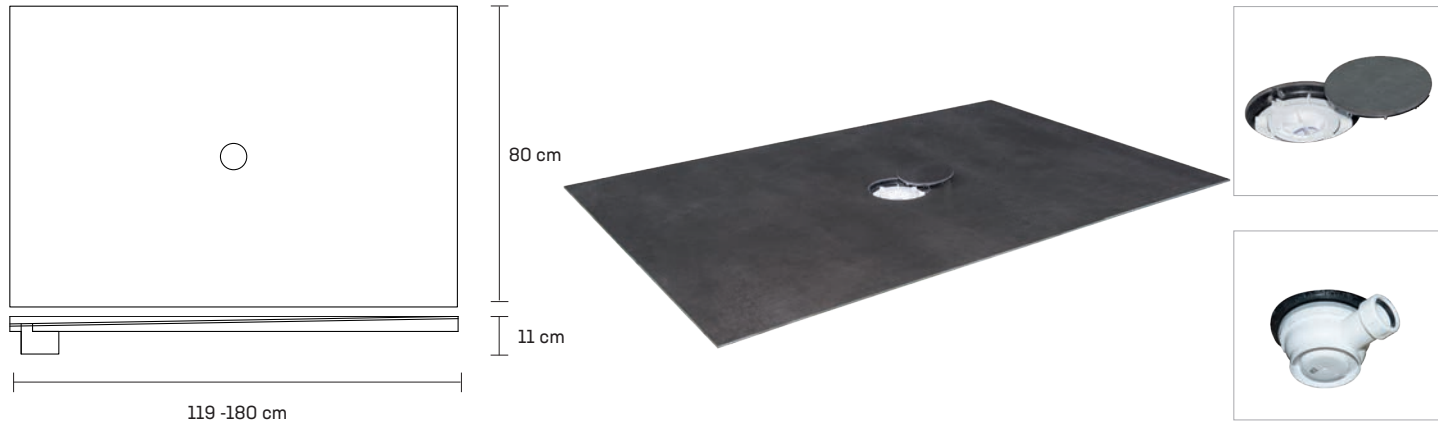

MODELLO B



COLORE COLOUR	MODELLO MODEL	FORMATO CM SIZE
Tutti i colori Krea / All Krea colors	A (termoformato / thermoformed)	119x80 48"x31 1/2" #4.8mm / #12mm
Tutti i colori Krea / All Krea colors	B (assemblato / assembled)	119x80 48"x31 1/2" #4.8mm / #12mm
Tutti i colori Krea / All Krea colors (no Red)		180x80 71"x31 1/2" #6mm

Tutte le informazioni tecniche inerenti ai piatti doccia le puoi trovare sulla brochure "Gigacer Service" e sul sito www.gigacer.it
You can find all technical information about shower trays in our brochure "Gigacer Service" and on our web site www.gigacer.it.

24 MM PAVIMENTI SOPRAELEVATI RAISED FLOORS

La resistenza di 2 lastre di 12 mm di spessore, incollate assieme con colla speciale garantisce un modulo di rottura di 18.140 kgf. #24 mm è resistente al gelo, ha un altissimo carico di rottura, è resistente ai sali, facile da pulire anche utilizzando idropulitrici, resistente agli attacchi di muffe, funghi, muschi e trattamenti al verderame. È rimovibile, riutilizzabile, antiscivolo, resistente al fuoco e facile da installare. #24 mm non cambia col tempo e resiste a tutte le condizioni climatiche, caratteristiche fondamentali per un pavimento esterno. La posa può essere fatta utilizzando diverse tecniche, secondo il tipo di superficie da ricoprire. Le lastre possono essere installate a secco direttamente su ghiaia, sabbia o altri substrati, possono essere stese su supporti sopraelevati (es. Eterno Ivica Pedestal) o incollate. L'installazione sopraelevata può essere effettuata con una struttura portante di moduli in polipropilene, che possono essere fissi, regolabili e autolivellanti. Hanno una altezza minima di 37,5 mm e massima di 230 mm. L'installazione sopraelevata consente una facile ispezione di cavi o condutture senza dover rompere il pavimento. #24mm pavimento sopraelevato è la migliore soluzione per luoghi residenziali o commerciali come balconi, vialetti, ecc. dal momento che protegge la superficie sottostante e consente ogni tipo di intervento tecnico. Consigliamo una fuga di 4mm per lo scolo dell'acqua.

The strength of 2 12 mm thick tiles glued together with a special glue grants a modulus of rupture of 18.140 Kgf. #24 mm is frostresistant, has a very high breakage load, it is resistant to salts, easy to clean also using pressure washers, resistant to the attack of mould, moss and verdigris treatments, removable, reusable, anti-slip, fire-resistant and very easy to install. #24 mm does not change and lasts over time in any climatic conditions, characteristics that are a must for outdoor floor coverings. Installation can be done using different techniques, according to the kind of surface. The porcelain stoneware slabs can be laid using a dry installation system, directly onto gravel or sand substrates as well as with raised installation (i.e. Eterno Ivica Pedestals) or glued. Raised installation is made with a support structure made of polypropylene, prefabricated, load-bearing modules, which can be fix, adjustable and self levelling. They have a minimum height of 37,5 mm and a maximum height of 230mm. Raised installation allows for easy inspection of underlying cabling and circuits without the need for burdensome work. #24mm raised floor is the best solution for residential and commercial destinations such as balconies, paths, access floors, etc., protecting the under-space and easily allowing any kind of technical intervention. A 4 mm joint is requested for water drainage.



I VANTAGGI DEL 24 MM THE ADVANTAGES OF 24 MM

- > Possibilità di avere un prodotto con lo stesso tono e superficie posato nelle aree interne ed esterne
- > Grande formato 120x120 in 24mm di spessore
- > Drenaggio efficace
- > Posa a secco
- > Durata e resistenza
- > Pulibilità
- > Ingelività

Lo stucco del bordo del 24 mm è colorato in tinta con il fondo scelto.

ESEMPI DI UTILIZZO DEL 24 MM

Pavimento sopraelevati / terrazzi all'aperto / terrazze chiuse / vialetti esterni / facciate ventilate / spiagge piscine / piatti doccia.

- > Possibility to have a product with the same tone and surface for indoor and the outdoor spaces
- > Big format 120x120 24 mm thickness
- > Efficient drainage
- > Dry laying
- > Endurance and strength
- > Cleanability
- > Frost resistance

The grout in the 24 mm thickness has the same colour of the tiles.

SOME EXAMPLES USING 24 MM

Raised access floors / open terraces / closed terraces / walkways / swimming pools / gardens / shower trays.

PIEDINI IN POLIPROPILENE
POLIPROPYLENE SUPPORTS

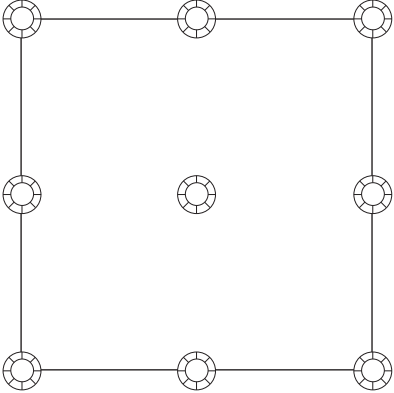
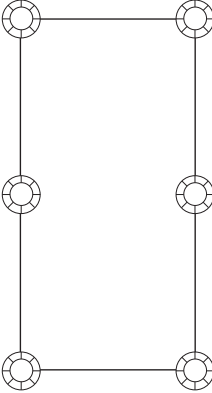
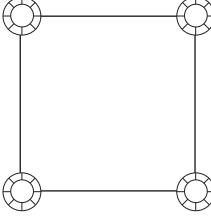
<p>120 x 120 cm / 48" x 48" 9 pz pcs / lastra slab</p>	<p>60 x 120 cm / 24" x 48" 6 pz pcs / lastra slab</p>	<p>60 x 60 cm / 24" x 24" 4 pz pcs / lastra slab</p>
		
<p>80 kg</p>	<p>40 kg</p>	<p>20 kg</p>



PEZZI SPECIALI - PLAYONE

PLAYONE - SPECIAL TRIMS

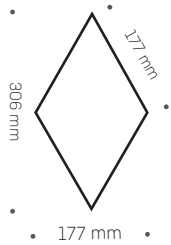

DIAMOND
18x31
7"x12"
±4.8 mm

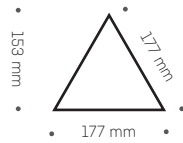

TRIANGLE
18x16
7"x6"
±4.8 mm



BRICK
9x18
3 1/2"x7"
±4.8 mm

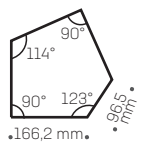

SMALL PENTAGON
17x10
7"x4"
±4.8 mm

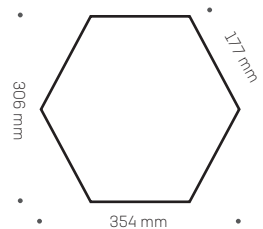

LARGE HEXAGON
36x31
14"x12"
±4.8 mm

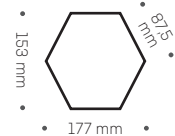

SMALL HEXAGON
18x16
7"x6"
±4.8 mm

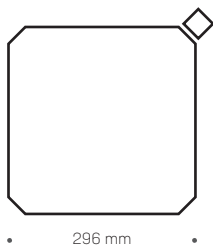

OCTAGON
30x30 cm
12"x12"
±4.8 mm



PLATE
9x30 cm
3 1/2"x12"
±4.8 mm

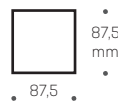

SMALL
9x9 cm
3 1/2"x3 1/2"
±4.8 mm

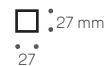

BUTTON
3x3 cm
1 1/4"x1 1/4"
±4.8 mm

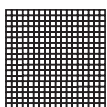

MOSAIC 1.5X1.5
30x30 cm 12"x12"
±4.8 mm

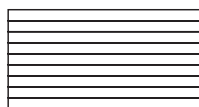

STRIPES MOSAIC
30x60 cm 12"x24"
±4.8 mm

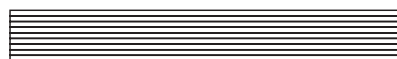

STRIPES MOSAIC
15x120 cm 6"x48"
±4.8 mm

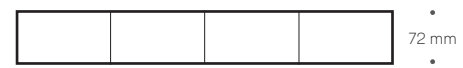

BRICK BAR
7,5x60 cm
3"x24"
±12 mm



PEZZI SPECIALI SPECIAL TRIMS

BATTISCOPIA SKIRTING

Battiscopa 60
#12mm

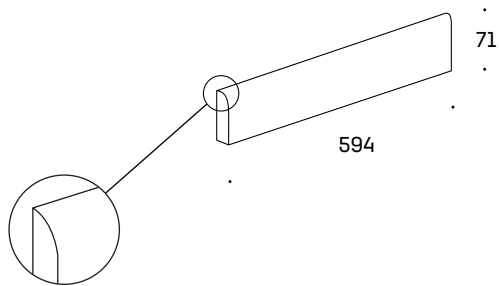

GRADONI COSTA RETTA COSTA RETTA STEPTREADS

Costa retta 60

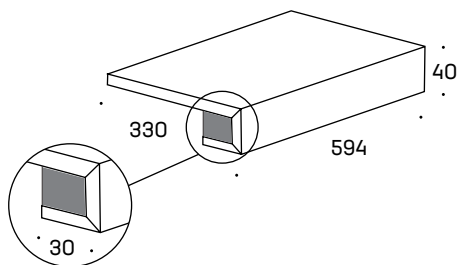

Costa retta 120

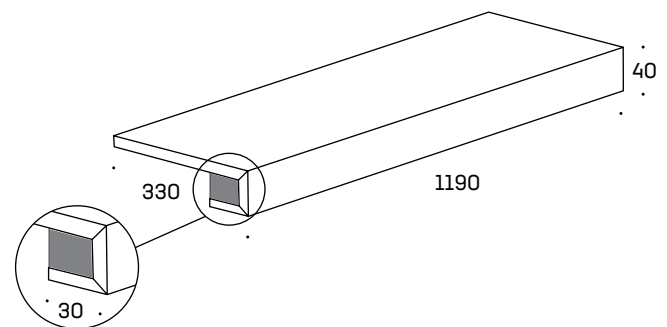

UTILIZZO

- Gradini per scale
- Davanzali
- Finitura terrazze e balconi
- Bordo piscine
- Interno o esterno

USE

- Steptreads for stairs
- Windowsills
- Terraces and balconies edge finish
- Poolside
- Indoor or outdoor

(1)
Tutte le misure sono in millimetri
All sizes are in millimetres

SERVIZI SPECIALI SPECIAL SERVICES



Gigacer Service è il servizio di lavorazioni su misura offerto da Gigacer su tutti i suoi prodotti. Consente di tagliare, forare, lucidare e in generale adattare le lastre al singolo progetto, seguendo le indicazioni di uno specifico disegno del cliente. In questo modo le lastre ceramiche possono essere utilizzate sia per realizzare elementi d'arredo, sia per personalizzare o adeguare al progetto le dimensioni di lastre per pavimento o rivestimento. Il pavimento o il rivestimento potrà così essere abbinato o addirittura identico al top cucina, ai gradini della scala, al top bagno o anche allo stesso lavabo, in una infinità possibilità di forme e dimensioni. Il pezzo unico viene realizzato anche seguendo le indicazioni e il disegno tecnico del progettista.

Gigacer Service is the firm's made to measure working service offered on all products. It enables slabs to be cut, perforated, polished and generally adapted to the individual project in line with the requisites of a specific client design. In this way the ceramic slabs can be used both to create decor elements and to personalise or adjust slab dimensions to flooring or decor designs. In this way the ceramic slabs can be matched with, or even identical to, the kitchen worktop, flights of steps, the bathroom worktop and even the basin in an infinity of possible forms and dimensions. Each single piece can be made in accordance with designers' instructions and technical drawings.

MODIFICHE SU RICHIESTA CHANGES ON REQUEST

È possibile richiedere la fattibilità e la quotazione per le seguenti modifiche:

- top squadrato invece che arrotondato
- top non smaltato (nel 12mm sarà visibile il multilayer)
- misure non standard: indicare misura X e Y in mm

It is possible to require the feasibility and the quotation for the following changes:

- squared top edge, instead of rounded
- unglazed top edge (on 12mm thickness the multilayer will be visible)
- bespoke sizes: please indicate X and Y in mm.

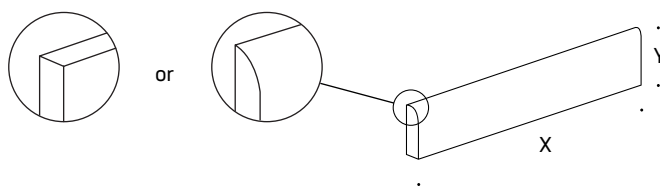

Le misure X, Y, Z e J sono modificabili a piacimento. Misura minima 30mm, massima 1900 per ogni variabile.

È possibile richiedere il gradone con chiusura su un lato o su entrambi, nel caso la scala sia aperta. Il pezzo può essere realizzato anche a vela senza rientranza. È necessario indicare tutte le misure richieste (A, B e C).

It is possible to request bespoke sizes on X, Y, Z and J. Minimum size 30mm, maximum 1900 for each variable.

It is possible to ask for one or both sides closed, if the staircase is open. The piece can be made without nose, only at 90°. All sizes must be specified (A, B and C).

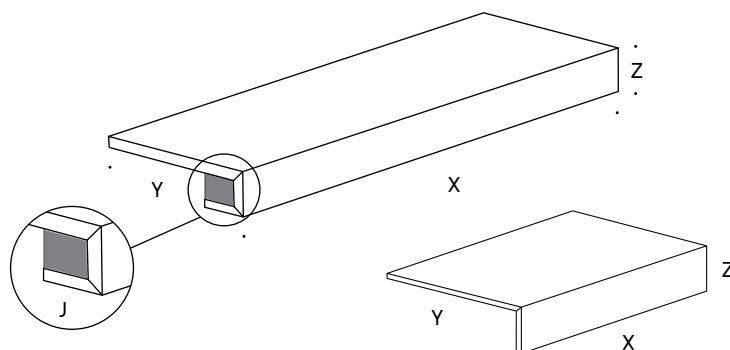

DESTINAZIONI D'USO INTENDED USE CLASSIFICATION

	PAVIMENTI NUOVE COSTRUZIONI	PAVIMENTI IN RISTRUTTURAZIONI	RIVESTIMENTI	COMMERCIALE LEGGERO	COMMERCIALE PESANTE	ESTERNI	SOPRELEVATO	PIANI DI LAVORO
	NEW FLOORS	FLOOR RENOVATION	WALL COVERING	LIGHT COMMERCIAL	HEAVY COMMERCIAL	OUTDOOR	RAISED FLOOR	COUNTERTOPS AND KITCHENTOPS
4,8 mm / 6 mm	+	++	++	+	--	-	--	-
12 mm multilayer	++	+	+	++	++	+	+	-
24 mm	-	-	-	-	++	++	++	-
	Posa a terra in nuove costruzioni su massetto.	Posa a terra su pavimenti esistenti, in ceramica o pietra naturale, o su massetto in costruzioni in stato di ristrutturazione.	Rivestimento muri.	Ambienti pubblici interni a medio traffico.	Ambienti pubblici interni ad alto traffico.	Ambienti esterni.	Pavimenti soprelavati con struttura flottante o posa su supporti in PVC.	
	Floor tiling on screed in new buildings.	Floor tiling on screed or an existing floor (in ceramic or natural stone) in buildings under renovation.	Wall covering.	Indoor public places subject to medium pedestrian traffic.	Indoor public places subject to heavy pedestrian traffic.	Outdoor places.	Raised floor with floating structure or PVC supports.	

++ Consigliato Recommended
 + Appropriato Suitable
 - Non consigliato Not recommended
 -- Non appropriato Not suitable

SUGGERIMENTI PER LA POSA INSTALLATION SUGGESTION

Le lastre di 6 mm sono: resistenti, sottili, leggere, facili da movimentare e da tagliare, resistenti al fuoco, ingelive, ecocompatibili e non necessitano di particolari accorgimenti per la manutenzione. È un prodotto ideale per pavimenti e rivestimenti interni ed esterni, ed è particolarmente adatto nel caso di ristrutturazione di pavimentazioni e rivestimenti residenziali: si applica sull'esistente senza opere di demolizione e relativi costi di smaltimento. Il nostro porcellanato sottile è abbinabile ai pavimenti con 2 mm di fuga della stessa collezione in spessori diversi, dei quali mantiene non solo le stesse caratteristiche estetiche, ma anche il medesimo calibro e modularità. Il 6 mm è un prodotto dal design ecologico: lo spessore ridotto comporta un minor impatto ambientale in termini di consumo di energia, materie prime, imballo e trasporti. Costituisce una valida alternativa al gres porcellanato di spessore tradizionale in tutti i casi in cui il minor spessore e la leggerezza costituiscono un fattore determinante. In fase di posa, le lastre di spessore 6 mm risultano perfettamente complanari.

SUGGERIMENTI PER LA POSA

INCOLLAGGIO: Doppia spalmatura (sul fondo e sul retro della piastrella).

TAGLIO: Normale taglierina da cantiere, sega a dischi diamantati.

FORATURA: trapani a punta per gres porcellanato, frese a tazza, idrogetto. Non usare il percussore e raffreddare con acqua nel punto di contatto.

6 mm slabs are resistant, thin, lightweight, easy to handle and cut, fire-resistant, frostproof, environmentally friendly and require no special care for maintenance. 6 mm is an ideal product for interior and exterior cladding. 6 mm slabs are particularly suitable in the case of renovation of residential floors and walls: they can be laid on the existing floor, allowing for a dramatic demolition and disposal cost savings. GIGACER 6 mm is suitable for indoor and outdoor wall covering and it is particularly indicated in all cases where it is preferable not to load too much weight on the building's structure. 6 mm can be combined with the 12 mm slabs of every collection because it has the same caliber and it is perfectly modular with 2 mm joints. 6 mm is a green product: it allows savings in terms of energy consumption, raw materials, packaging and transport. It is a valid alternative to the traditional 12 mm in all those cases where lightness and less thickness represent a determinant variable. 6 mm tiles can be fixed together on the same surface, as the real difference in thickness is minimal.

INSTALLATION SUGGESTIONS

GLUING: Double spreading (on substrate and on the back of the tile)

CUTTING: Standard dry diamond clipper for porcelain tiles, bench machines with diamond disks.

DRILLING: Drills with porcelain drill tips, hollow mills or hose-mounted drill bits (for large size holes), hydrojet. Never use the hammer function when drilling, and cool with water while drilling.

INDICE DI STONALIZZAZIONE SHADE VARIATION INDEX

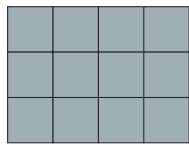

V1 / LOW

Prodotto monocromatico
Monochromatic product

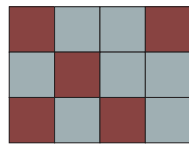

V2 / MODERATE

Prodotto con leggera
variazione cromatica
Product with light
chromatic variation

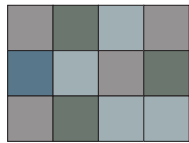

V3 / HIGH

Prodotto con marcata
variazione cromatica
Product with high
chromatic variation

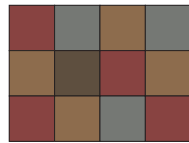

V4 / VERY HIGH

Prodotto con forte
variazione cromatica
Product with very high
chromatic variation

SUPERFICE SURFACES	STONALIZZAZIONE SHADE VARIATION
Krea	V3
Krea Playone	V3
Krea Mosaic	V3

CALIBRI CALIBER

Le nostre lastre sono sempre rettificate e hanno dimensioni finali in millimetri come da tabella. Il calibro standard è lo 09 e i formati dello stesso calibro multipli tra loro sono modulari con 2 mm di fuga.







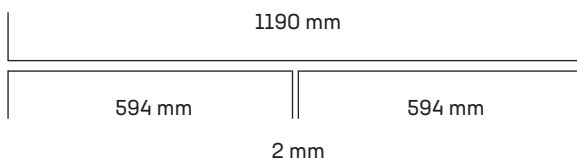







Our slabs are always rectified and the table below indicates their final size in millimetres. Our standard caliber is 09 and all sizes with the same caliber, when multiples, are modular with 2 mm joint spacing.

FORMATO NOMINALE (CM) NOMINAL SIZE (CM)	FORMATO RETTIFICATO (MM) RECTIFIED SIZE (MM)	CALIBRO CALIBER
120x250	1190x2500	09
60x250	594x2500	09
120x120	1190x1190	09
60x120	594x1190	09
60x60	594x594	09
30x60	296x594	09

MODULARITÀ MODULARITY



CARATTERISTICHE TECNICHE TECHNICAL SPECIFICATION

LASTRE DI GRES PORCELLANATO / PORCELAIN SLABS ISO 13006 - G - Blα UGL (E ≤ 0,5%) UNI EN 14411 - G -					
	CARATTERISTICHE TECNICHE TECHNICAL SPECIFICATIONS	NORMA ISO STANDARD	SPESSORE THICKNESS	VALORI PRESCRITTI DALLE NORME INTERNATIONAL STANDARDS	VALORE MEDIO GIGACER AVERAGE GIGACER VALUE
	CARATTERISTICHE DIMENSIONALI DIMENSIONAL CHARACTERISTICS			S > 410	
	LATI SIDES	ISO 10545-2		± 0,6%	± 0,2%
	SPESSORE THICKNESS			± 5%	± 3%
	RETTILINEITÀ DEGLI SPIGOLI STRAIGHTNESS OF EDGES			± 0,5%	± 0,2%
	ORTOGONALITÀ RECTANGULARITY			± 0,6%	± 0,2%
	PLANARITÀ SURFACE FLATNESS			± 0,5%	± 0,2%
	ASSORBIMENTO D'ACQUA WATER ABSORPTION	ISO 10545-3		≤ 0,5%	≤ 0,1%
	RESISTENZA ALLA FLESSIONE BENDING STRENGTH	ISO 10545-4	≠ 4,8 mm	≥ 35N/mm ²	≥ 40 N/mm ²
			≠ 6 mm	≥ 35N/mm ²	≥ 40 N/mm ²
			≠ 12 mm	≥ 35N/mm ²	≥ 40 N/mm ²
	MODULO DI ROTTURA MODULUS OF RUPTURE	ISO 10545-4	≠ 4,8 mm	> 700N (sp. < 7,5mm)	> 700 N
			≠ 6 mm	> 700N (sp. < 7,5mm)	> 700 N
			≠ 12 mm	> 1.300N (sp. ≥ 7,5mm)	≥ 4000 N
			≠ 24 mm	> 1.300N (sp. ≥ 7,5mm)	18,14 kN (=18.140 kgF)
	RESISTENZA ALL'ABRASIONE PROFONDA RESISTANCE TO DEEP ABRASION	ISO 10545-6		≤ 175mm ³	≤ 145 mm ³
	COEFFICIENTE DI DILATAZIONE TERMICA LINEARE COEFFICIENT OF LINEAR THERMAL EXPANSION	ISO 10545-8		≤ 9x10 ⁻⁶ °c ⁻¹	≤ 7x10 ⁻⁶ °c ⁻¹
	RESISTENZA AGLI SBALZI TERMICI RESISTANCE TO THERMAL SHOCKS			METODO DISPONIBILE AVAILABLE METHOD	RESISTE RESISTANT
	RESISTENZA AL GELO FROST RESISTANCE	ISO 10545-12		METODO DISPONIBILE AVAILABLE METHOD	RESISTE RESISTANT
	RESISTENZA ALL'ATTACCO CHIMICO RESISTANCE TO CHEMICAL ATTACKS	ISO 10545-13		min. UB	RESISTE RESISTANT
	RESISTENZA ALLE MACCHIE STAIN RESISTANCE	ISO 10545-14		METODO DISPONIBILE AVAILABLE METHOD	RESISTE RESISTANT

T Trattandosi di un prodotto tecnico a solo impasto senza smalto alcune impurità e puntinature visibili nei colori chiari sono da considerarsi una caratteristica tecnica del prodotto.
T We produce technical unglazed porcelain stoneware slabs, and some light impurities and dots must be considered as a standard feature of the product.

NOTE TECNICHE TECHNICAL NOTES

COEFFICIENTE DI ATTRITO / COEFFICIENT OF FRICTION
LASTRE DI GRES PORCELLANATO / PORCELAIN SLABS
ISO 13006 - G - Bla UGL (E ≤ 0,5%) UNI EN 14411 - G -

		SUPERFICI SURFACES	SPESSORE THICKNESS	DIN 51130	DIN 51097	BCR	BRITISH PENDULUM BS7976	R9729 UPI/EMPA	DCOF (SECTION 9.6 ANSI A 137.1.2012)
	COEFFICIENTE D'ATTRITO COEFFICIENT OF FRICTION	KREA	#4.8mm	R10	A + B*	> 0,40	-	GS1	-
			#6mm	R10	A + B*	> 0,40	-	GS1	-
			#12mm #24mm	R10	A + B	> 0,40	> 36 WET	GS2/GB1	> 0,42 wet

* Valore medio / Average value

I valori di resistenza allo scivolamento, coefficiente di attrito statico e dinamico, riportati sul catalogo e sul sito, sono da ritenersi puramente indicativi e non vincolanti. Ogni eventuale specifica necessità dovrà essere da noi confermata al momento dell'ordine e comunque sempre prima della posa. / The values of slip resistance and of static and dynamic friction coefficient shown in the catalogue, and in the web site are merely indicative and non-binding. Any possible specific requirement must be confirmed by us at the order and anyway always before the installation.



IMBALLI PACKAGING

Curiamo con particolare attenzione gli imballi del materiale 4,8 mm e 6mm per scongiurare qualsiasi rischio di rottura dovuta alle sollecitazioni del viaggio. Il cartone utilizzato proviene al 100% da fonti riciclate e il legno, fumigato secondo le norme ISPM-15, sostiene il peso di eventuali pallet (sempre Gigacer) sovrapposti scaricandolo a terra. È importante sovrapporre i pallet dello stesso formato, e non euro pallet con pallet 120x120. Gigacer non si assume nessuna responsabilità per danni causati al materiale da errate manovre di carico o scarico, da movimentazioni non autorizzate o da eventi accidentali di qualsiasi tipo.

We pay close attention to the 4.8 mm and 6mm products packaging, to avoid any risk of breakage during shipping. The cardboards used come from recycled sources 100%, and wood, fumigated according to ISPM-15, supports the weight of any pallet (gigacer pallets) stacked. It is important to stack only pallets of the same size. Gigacer assumes no responsibility for damages caused by incorrect handling of the material loading or unloading, unauthorized handling or accidents of any kind.

Formato Size (cm)	Pallet (cm)	Pezzi x collo PCS/BX	M² x collo SQM/BX	Kg x collo KG/BX	Colli x pallet BX/PLT	M² x pallet SQM/PLT	Kg x pallet KG/PLT
24 mm							
120x120	120x120	1	1,44	82,00	12	17,28	1010
60x120	120x120	1	0,72	41,00	24	17,28	1010
60x60	120x120	1	0,36	20,50	48	17,28	1010
12 mm							
120x120	120x120	1	1,44	40,20	36	51,84	1482
60x120	120x120	2	1,44	40,20	36	51,84	1482
60x60	120x120	3	1,08	30,20	48	51,84	1482
30x60	120x120	4	0,72	20,20	72	51,84	1482
Brick Bar	80x120	12	0,54	14,00	40	2,16	593
Battiscopa / Skirting 60x71	-	10	-	16,00	-	-	-
Gradino costa retta Costa retta step 60x33x4	-	4	-	26,00	-	-	-
Gradino costa retta Costa retta step 120x33x4	-	2	-	26,00	-	-	-
6 mm							
120x250	272x133x42h	1	3,00	42,60	22	66,00	1038
60x250	272x133x42h	1	1,50	21,00	44	66,00	1024
4.8 mm							
120x120	124x137	2	2,88	35,00	23	66,24	835
60x120	124x137	4	2,88	34,50	24	69,12	870
60x60	124x137	5	1,80	21,60	40	72,00	904
30x60	124x137	10	1,80	21,60	48	86,40	1077
Mosaic 30x30 (1,5x1,5)	-	10	-	13,00	-	-	-
Stripes Mosaic 30x60	-	6	-	11,00	-	-	-
Stripes Mosaic 15x120	-	4	-	7,00	-	-	-
Button	-	22	0,02	0,20	-	-	-
Small	-	44	0,36	3,95	-	-	-
Brick	-	22	0,36	3,95	-	-	-
Plate	-	22	0,60	6,45	-	-	-
Octagon	-	22	1,98	23,70	-	-	-
Small Pentagon	-	24	0,96	11,50	-	-	-
Large Hexagon	-	14	1,18	13,00	-	-	-
Small Hexagon	-	11	0,23	3,00	-	-	-
Triangle	-	18	0,24	2,92	-	-	-
Diamond	-	9	0,24	2,92	-	-	-

CERTIFICAZIONI CERTIFICATIONS

GIGACER ha conseguito le certificazioni di processo ISO 9001:2015 e ISO 14001:2015. GIGACER ha conseguito le certificazioni UNI EN 14411:2012. La qualità dei prodotti GIGACER viene controllata costantemente tramite test effettuati dai principali laboratori ed enti di certificazione internazionali. L'ultima certificazione ottenuta, in ordine di tempo, è la QB-UPEC per alcune superfici, con risultati brillanti. E' possibile scaricare la lista completa dei prodotti Gigacer che hanno ottenuto la certificazione QB-UPEC, completa di valori, al seguente url: www.cstb.fr

GIGACER has achieved the process certifications ISO 9001:2015 e ISO 14001:2015. GIGACER has achieved the process certifications UNI EN 14411:2012. The quality of GIGACER products is constantly monitored with tests made by the main international certification laboratories. The last certification achieved is the QB-UPEC in some surfaces, with brilliant results. It is possible to download the list of Gigacer products that obtained QB-UPEC certification with all the values at the following url: www.cstb.fr



“  ”
Ceramics of Italy



Non si danneggia con i detergenti chimici anticovid.
Does not damage with chemical detergents anticovid.

MADE IN ITALY
MADE IN FAENZA

Quanto contenuto nel catalogo è puramente indicativo riguardo a colori e decorazioni.
Real colours and decorations might slightly differ from those depicted in this catalogue.



GIGACER®

GIGACER S.P.A.
via Caltagirone, n.72 / 48018 Faenza (RA) ITALY
Tel. +39 0546 637 111 / Fax +39 0546 637 127
info@gigacer.it / www.gigacer.it

CREDITS
Progetto grafico: mpronline.it



GIGACER S.P.A.
via Caltagirone, n.72 / 48018 Faenza (RA) ITALY
Tel. +39 0546 637 111 / Fax +39 0546 637 127
info@gigacer.it
gigacer.it